

**MEMORANDUM**

**To:** Mayor and City Council

**From:** Michael Smith, Public Works Director

**Date:** December 14, 2015

**Subject:** **Consideration of Pole Attachment Agreement with Crown Castle. (Lenny Felgin)**

---

**ITEM DESCRIPTION**

Consideration of a pole attachment agreement with Crown Castle to allow for installation of small cellular antennae on city owned poles.

**BACKGROUND**

Representatives of Crown Castle have requested the city's consideration of an agreement to attach microcellular antennae and related equipment to city owned poles. Terms of the proposed agreement include:

- Five year initial duration with automatic renewal for three successive five year terms.
- Compensation will be provided to the city in the amount of \$500 per facility per year with an adjustment every 5 years based on the Consumer Price Index.
- Crown Castle is required to obtain city approval prior to installing equipment on any city owned poles.
- The agreement may be terminated for default with 45 days written notice.

*City of Dunwoody, Georgia*

**MUNICIPAL POLE ATTACHMENT AGREEMENT**

**T** HIS MUNICIPAL POLE ATTACHMENT AGREEMENT (this "Agreement") is dated as of \_\_\_\_\_, 2015 (the "Effective Date"), and entered into by and between the **CITY OF DUNWOODY**, a Georgia municipal corporation (the "City"), and **CROWN CASTLE NG EAST LLC**, a Delaware limited liability company f/k/a Crown Castle NG East Inc. ("Crown Castle").

**RECITALS**

- A. **WHEREAS**, Crown Castle owns, constructs, maintains, operates and controls, in accordance with regulations promulgated by the Federal Communications Commission and the Georgia Public Service Commission, a fiber-based telecommunications Network or Networks (as defined below) serving Crown Castle's customers and utilizing microcellular Equipment (as defined below) certified by the Federal Communications Commission; and
  
- B. **WHEREAS**, The City owns, operates and maintains Municipal Facilities (as defined below) in the Public Way (as defined below); and
  
- C. **WHEREAS**, For the purpose of operating the Network, Crown Castle wishes to locate, place, attach, install, operate, control, and maintain Equipment in the Public Way (as defined below) on Municipal Facilities.

**AGREEMENT**

**NOW, THEREFORE**, for good and valuable consideration, the receipt and sufficiency of which are hereby acknowledged and incorporated herein, the parties agree to the following covenants, terms, and conditions:

- 1 DEFINITIONS.** The following definitions shall apply generally to the provisions of this Agreement:
  - 1.1 City.** ("City") shall mean the City of Dunwoody, Georgia, including all of its operating departments and divisions.
  
  - 1.2 Crown Castle.** "Crown Castle" shall mean **Crown Castle NG East LLC**, a Delaware limited liability company f/k/a Crown Castle NG East Inc., and its lawful successors, assigns, and transferees.
  
  - 1.3 Decorative Streetlight Pole.** "Decorative Streetlight Pole" shall mean any streetlight pole that incorporates artistic design elements not typically found in standard steel, concrete or aluminum streetlight poles.
  
  - 1.4 Equipment.** "Equipment" means the optical converters, multiplexers, antennas, fiber optic cables, wires, and related equipment, whether referred to singly or collectively, to be installed and operated by Crown Castle hereunder. Examples of typical Equipment types and installation

configurations are shown in the drawings and photographs attached hereto as **Exhibit A** and incorporated herein by reference.

**1.5 Fee.** "Fee" means any assessment, license, charge, fee, imposition, tax, or levy of general application to entities doing business in the City lawfully imposed by any governmental body (but excluding any utility users' tax, franchise fees, communications tax, or similar tax or fee).

**1.6 ILEC.** "ILEC" means the Incumbent Local Exchange Carrier that provides basic telephone services, among other telecommunications services, to the residents of the City.

**1.7 Installation Date.** "Installation Date" shall mean the date that the first Equipment is installed by Crown Castle pursuant to this Agreement.

**1.8 Laws.** "Laws" means any and all statutes, constitutions, ordinances, resolutions, regulations, judicial decisions, rules, tariffs, administrative orders, certificates, orders, or other requirements of the City or other governmental agency having joint or several jurisdiction over the parties to this Agreement.

**1.9 Municipal Facilities.** "Municipal Facilities" means City-owned structures located within the Public Way, including utility poles, Streetlight Poles, Decorative Streetlight Poles, lighting fixtures, electroliers, Traffic Signal Poles, catenary poles, sign posts, or other City-owned infrastructure and may refer to such facilities in the singular or plural, as appropriate to the context in which used.

**1.10 Network.** "Network," or collectively "Networks," means one or more of the neutral-host, protocol-agnostic, fiber-based optical networks, which may incorporate third party equipment, operated exclusively by Crown Castle to serve its customers in the City.

**1.11 Public Way.** "Public Way" means the space in, upon, above, along, across, and over the public streets, roads, highways, lanes, courts, ways, alleys, boulevards, sidewalks, bicycle lanes, and places, including all public utility easements and public service easements as the same now or may hereafter exist, that are under the jurisdiction of the City. This term shall not include county, state, or federal rights of way or any property owned by any person or entity other than the City, except as provided by applicable Laws or pursuant to an agreement between the City and any such person or entity.

**1.12 PSC.** "PSC" means the Georgia Public Service Commission.

**1.13 Services.** "Services" means the RF transport and other telecommunications services provided through the Network by Crown Castle to its customers.

**1.14 Streetlight Pole.** "Streetlight Pole" shall mean any pole used primarily for streetlighting purposes.

**1.15 Traffic Signal Pole.** "Traffic Signal Pole" shall mean any pole used primarily to support vehicular or pedestrian traffic signalization.

**2 TERM.** This Agreement shall be effective as of the Effective Date and shall extend for a term of five (5) years commencing on the Installation Date, unless it is earlier terminated by either party in accordance with the provisions herein. The term of this Agreement shall be renewed automatically for three (3) successive terms of five (5) years each on the same terms and conditions as set forth herein, unless Crown Castle notifies the City of its intention not to renew not less than thirty (30) calendar days prior to commencement of the relevant renewal term.

**3 SCOPE OF AGREEMENT.** Any and all rights expressly granted to Crown Castle under this Agreement, which shall be exercised at Crown Castle's sole cost and expense, shall be subject to the prior and continuing right of the City under applicable Laws to use any and all parts of the Public Way exclusively or concurrently with any other person or entity and shall be further subject to all deeds, easements, dedications, conditions, covenants, restrictions, encumbrances, and claims of title of record which may affect the Public Way. Nothing in this Agreement shall be deemed to grant, convey, create, or vest in Crown Castle a real property interest in land, including any fee, leasehold interest, or easement. Any work performed pursuant to the rights granted under this Agreement shall be subject to the reasonable prior review and approval of the City except that it is agreed that no zoning or planning board permit, variance, conditional use permit or site plan permit, or their equivalent under the City's ordinances, codes or laws, shall be required for the installation of Crown Castle's Equipment installed in the Public Way and/or on Municipal Facilities, unless such a process has been required for the placement of all communications facilities and equipment in the Public Way by all other telecommunications providers, including but not limited to the ILEC and local cable provider(s).

**3.1 Attachment to Municipal Facilities.** The City hereby authorizes and permits Crown Castle to enter upon the Public Way and to locate, place, attach, install, operate, maintain, control, remove, reattach, reinstall, relocate, and replace Equipment in or on Municipal Facilities for the purposes of operating the Network and providing Services. Crown Castle has the right to draw compatible electricity for the operation of the Equipment from the power source associated with City poles upon approval of a service order application from the applicable utility provider, provided that Crown Castle shall not connect its Equipment to, nor draw any power from, any traffic signal device. Crown Castle shall be solely responsible for the payment of all electrical utility charges as set forth in paragraph 4.4 below.

**3.2 Abandonment.** If Crown Castle abandons Equipment it owns attached to City poles, then, to the extent not inconsistent with applicable law, Crown Castle shall remove such Equipment within 90 days. Equipment shall be considered "abandoned" if Crown Castle has not used such equipment for its intended purpose for more than 180 consecutive days.

**3.3 Inspection.** Crown Castle shall inspect the Equipment to ensure that all attachments are structurally sound and that the equipment is operating properly not less than once per year.

**3.2 Preference for Municipal Facilities.** In any situation where Crown Castle has a choice of attaching its Equipment to either Municipal Facilities or third-party-owned property in the Public Way, Crown Castle agrees to attach to the Municipal Facilities, provided that: (i) such Municipal Facilities are at least equally suitable functionally for the operation of the Network; and (ii) the rental fee and installation costs associated with such attachment over the length of the term are equal to or less than the fee or cost to Crown Castle of attaching to the alternative third-party-owned property.

**3.3 No Interference.** Crown Castle, in the performance and exercise of its rights and obligations under this Agreement, shall not interfere in any manner with the existence and operation of any and all public and private rights of way, sanitary sewers, water mains, storm drains, gas mains, poles, aerial and underground electrical and telephone wires, electroliers, cable television, and other telecommunications, utility, or municipal property, without the express written approval of the owner or owners of the affected property or properties, except as permitted by applicable Laws or this Agreement.

**3.4 Compliance with Laws.** Crown Castle shall comply with all applicable Laws in the exercise and performance of its rights and obligations under this Agreement.

**4 COMPENSATION; UTILITY CHARGES.** Crown Castle shall be solely responsible for the payment of all lawful Fees in connection with Crown Castle's performance under this Agreement, including those set forth below.

**4.1 Annual Fee.** In order to compensate the City for Crown Castle's use of Municipal Facilities, Crown Castle shall pay to the City an annual fee (the "Annual Fee") in the amount of Five Hundred Dollars (\$500.00) for the use of each Municipal Facility, upon which Equipment has been installed pursuant to this Agreement. The aggregate Annual Fee with respect to each year of the term shall be an amount equal to the number of Equipment installed on Municipal Facilities during the preceding twelve (12) months multiplied by the Annual Fee, prorated as appropriate, and shall be due and payable not later than forty-five (45) days after each anniversary of the Installation Date. For the purpose of calculating the Annual Fee remittance, all Equipment attached by Crown Castle to one Municipal Facility shall constitute one installation and therefore a single use of a Municipal Facility. The City represents and covenants that the City owns all Municipal Facilities for the use of which it is collecting from Crown Castle the Annual Fee pursuant to this § 4.1.

**4.1.1 CPI Adjustment.** Effective commencing on the fifth (5<sup>th</sup>) anniversary of the Installation Date and continuing on each fifth (5<sup>th</sup>) anniversary thereafter during the term, the Annual Fee with respect to the ensuing five-year period shall be adjusted by a percentage amount equal to the percentage change in the U.S. Department of Labor, Bureau of Labor Statistics Consumer Price Index for the South.

**4.2 Accounting Matters.** Crown Castle shall keep accurate books of account for the purpose of determining the amounts due to the City under § 4.1 above and shall make records relative to this agreement available for the City to inspect upon thirty (30) days' prior written notice. Such audit of the books shall be at the City's sole expense and only to the extent necessary to confirm the accuracy of payments due under § 4.1 above. The City agrees to hold in confidence any non-public information it learns from Crown Castle to the fullest extent permitted by Law.

**4.3 Electricity Charges.** For all electrical power obtained from third party providers, Crown Castle shall be solely responsible for the payment of all electrical utility charges to the applicable utility provider for the electricity charges attributable to Crown Castle.

**CONSTRUCTION.** Crown Castle shall comply with all applicable federal, State, and City codes, specifications, and requirements, if any, related to the construction, installation, operation, maintenance, and control of Crown Castle's Equipment installed in the Public Way and on Municipal Facilities in the City. Crown Castle shall not attach, install, maintain, or operate any Equipment in or on the Public Way or on Municipal Facilities without the prior approval of the City for each location. The Application for each of the City's facilities must include drawings and diagrams depicting the location(s) and proposed manner of installation. The City may refuse to allow attachment of Telecommunications Equipment to Municipal Facilities where there is insufficient capacity, or for reasons related to aesthetics, safety, reliability, or generally applicable engineering standards.

**4.4 Obtaining Required Permits.** If the attachment, installation, operation, maintenance, or location of the Equipment in the Public Way shall require any permits, Crown Castle shall, if required under applicable City ordinances, apply for the appropriate permits and pay required permit fees, so long as the permit fees and process that the City requests of Crown Castle are functionally equivalent to the fees and the process that are applied to the ILEC and/or the cable provider(s). The City agrees to use reasonable efforts to review and approve Crown Castle's applications within thirty (30) days of submission.

**4.5 Location of Equipment.** The proposed locations of Crown Castle's planned initial installation of Equipment shall be provided to the City prior to deployment of the Equipment. Upon the completion of installation, Crown Castle promptly shall furnish to the City a list showing the location(s) of Municipal Facilities to which Crown Castle has attached its Equipment in the Public Way and the date of initial installation. Additional installations during the term of this Agreement shall be approved and installed in accordance with this Agreement, and said "pole" list updated upon each installation.

**4.6 Relocation and Displacement of Equipment.** Crown Castle understands and acknowledges that the City may require Crown Castle to relocate one or more of its Equipment installations. Crown Castle shall at the City's direction relocate such Equipment at Crown Castle's sole cost and expense, whenever the City reasonably determines that the relocation is needed for any of the following purposes: (a) if required for the construction, completion, repair, relocation, or maintenance of a City project; (b) because the Equipment is interfering with or adversely affecting proper operation of any City-owned light poles, traffic signals, or other equipment in the Public Way; or (c) to protect or preserve the public health or safety. In any such case, the City shall use its best efforts to afford Crown Castle a reasonably equivalent alternate location. If Crown Castle shall fail to relocate any Equipment as requested by the City within a reasonable time under the circumstances in accordance with the foregoing provision, the City shall be entitled to relocate the Equipment at Crown Castle's sole cost and expense, without further notice to Crown Castle. To the extent the City has actual knowledge thereof, the City will attempt promptly to inform Crown Castle of the displacement or removal of any pole on which any Equipment is located.

**4.7 Relocations at Crown Castle's Request.** In the event Crown Castle desires to relocate any Equipment from one Municipal Facility to another, Crown Castle shall so advise the City. The City will use its best efforts to accommodate Crown Castle by making another reasonably equivalent Municipal Facility available for use in accordance with and subject to the terms and conditions of this Agreement.

**4.8 Damage to Public Way.** Whenever the removal or relocation of Equipment is required or permitted under this Agreement, and such removal or relocation shall cause the Public Way or Municipal Facilities to be damaged, Crown Castle, at its sole cost and expense, shall promptly repair and return the Public Way and Municipal Facilities in and on which the Equipment is located to a safe and satisfactory condition in accordance with applicable Laws, normal wear and tear excepted. If Crown Castle does not repair the site as just described, then the City shall have the option, upon fifteen (15) days' prior written notice to Crown Castle, to perform or cause to be performed such reasonable and necessary work on behalf of Crown Castle and to charge Crown Castle for the proposed costs to be incurred or the actual costs incurred by the City at the City's standard rates. Upon the receipt of a demand for payment by the City, Crown Castle shall promptly reimburse the City for such costs.

**5 INDEMNIFICATION AND WAIVER.** Crown Castle agrees to indemnify, defend, protect, and hold harmless the City, its elected officials, council members, officers, agents and employees from and against any and all claims, demands, losses, damages, liabilities, fines, charges, penalties, administrative and judicial proceedings and orders, judgments, and all costs and expenses incurred in connection therewith, including reasonable attorney's fees and costs of defense (collectively, the "Losses") directly or proximately resulting from Crown Castle's activities undertaken pursuant to this Agreement, except to the extent arising from or caused by the negligence or willful misconduct of the City, its council or board members, officers, elected trustees, employees, agents, or contractors.

**5.1 Waiver of Claims.** Crown Castle waives any and all claims, demands, causes of action, and rights it may assert against the City on account of any loss, damage, or injury to any Equipment or

any loss or degradation of the Services as a result of any event or occurrence which is beyond the reasonable control of the City.

**5.2 Limitation of Liability.** The City shall be liable only for the cost of repair to damaged Equipment arising from the negligence or willful misconduct of the City, its employees, agents, or contractors. In no event shall either party be liable for indirect, consequential, or punitive damages.

**6 INSURANCE.** Crown Castle shall obtain and maintain at all times during the term of this Agreement Commercial General Liability insurance and Commercial Automobile Liability insurance protecting Crown Castle in an amount not less than One Million Dollars (\$1,000,000) per occurrence (combined single limit), including bodily injury and property damage, and the Commercial General Liability insurance in an amount not less than Two Million Dollars (\$2,000,000) annual aggregate for personal injury liability and products-completed operations. The Commercial General Liability insurance policy shall name the City, its elected officials, officers, agents and employees as additional insureds as respects any covered liability arising out of Crown Castle's performance of work under this Agreement. Coverage shall be in an occurrence form and in accordance with the limits and provisions specified herein. Claims-made policies are not acceptable. Such insurance shall not be canceled without replacement, nor shall the occurrence or aggregate limits set forth above be reduced, until the City has received at least thirty (30) days' advance written notice of such cancellation or change. Crown Castle shall be responsible for notifying the City of such change or cancellation.

**6.1 Filing of Certificates and Endorsements.** Prior to the commencement of any work pursuant to this Agreement, Crown Castle shall file with the City the required original certificate(s) of insurance with endorsements, which shall state the following:

- (a) the policy number; name of insurance company; name and address of the agent or authorized representative; name and address of insured; project name; policy expiration date; and specific coverage amounts;
- (b) that Crown Castle's Commercial General Liability insurance policy is primary as respects any other valid or collectible insurance that the City may possess, including any self-insured retentions the City may have; and any other insurance the City does possess shall be considered excess insurance only and shall not be required to contribute with this insurance; and
- (c) that Crown Castle's Commercial General Liability insurance policy waives any right of recovery the insurance company may have against the City.

The certificate(s) of insurance with endorsements and notices shall be mailed to the City at the address specified in § 8 below.

**6.2 Workers' Compensation Insurance.** Crown Castle shall obtain and maintain at all times during the term of this Agreement statutory workers' compensation and employer's liability insurance in an amount not less than One Million Dollars (\$1,000,000) and shall furnish the City with a certificate showing proof of such coverage.

**6.3 Insurer Criteria.** Any insurance provider of Crown Castle shall be admitted and authorized to do business in the State of Georgia and shall carry a minimum rating assigned by *A.M. Best & Company's Key Rating Guide* of "A" Overall and a Financial Size Category of "X" (*i.e.*, a size of \$500,000,000 to \$750,000,000 based on capital, surplus, and conditional reserves). Insurance policies and certificates issued by non-admitted insurance companies are not acceptable.

**6.4 Severability of Interest.** Any insurance policy deductibles or self-insured retentions shall be the responsibility of Crown Castle. The City shall have no responsibility to pay or reimburse either. Any self-insured retention shall be listed on the certificate of insurance and be subject to approval by the City, which approval shall not be unreasonably withheld. The Commercial General Liability and Automobile Liability policies shall each contain a severability of interest or separation of insureds clause such that the insurance applies to each insured as if they were the only insured and separately to each insured against whom a claim is made, except for insurance policy limits.

**7 NOTICES.** All notices which shall or may be given pursuant to this Agreement shall be in writing and delivered personally or transmitted: (a) through the United States mail, by registered or certified mail, postage prepaid; (b) by means of prepaid overnight delivery service; or (c) by facsimile or email transmission, if a hard copy of the same is followed by delivery through the U. S. mail or by overnight delivery service as just described, addressed as follows:

*if to the City:*

City OF **DUNWOODY**  
41 Perimeter Center East  
Suite 250  
Dunwoody, GA 30346

*if to Crown Castle:*

**CROWN CASTLE NG EAST LLC**  
c/o Crown Castle  
Attn: E. Blake Hawk, General Counsel  
2000 Corporate Drive  
Canonsburg, PA 15317

*with a copy which shall not constitute legal notice to*

**CROWN CASTLE NG EAST LLC**  
c/o Crown Castle  
Attn: SCN Contract Management  
2000 Corporate Drive  
Canonsburg, PA 15317

**7.1 Date of Notices; Changing Notice Address.** Notices shall be deemed given upon receipt in the case of personal delivery, three (3) days after deposit in the mail, or the next business day in the case of facsimile, email, or overnight delivery. Either party may from time to time designate any other address for this purpose by written notice to the other party delivered in the manner set forth above.

**8 TERMINATION.** This Agreement may be terminated by either party upon forty five (45) days' prior written notice to the other party upon a default of any material covenant or term hereof by the other party, which default is not cured within forty-five (45) days of receipt of written notice of default (or, if such default is not curable within forty-five (45) days, if the defaulting party fails to commence such cure within forty-five (45) days or fails thereafter diligently to prosecute such cure to completion), provided that the grace period for any monetary default shall be ten (10) days from receipt of notice.

**9 ASSIGNMENT.** This Agreement shall not be assigned by Crown Castle without the express written consent of the City. Notwithstanding the foregoing, the transfer of the rights and obligations of Crown Castle to a parent, subsidiary, or other affiliate of Crown Castle or to any successor in interest or entity



acquiring fifty-one percent (51%) or more of Crown Castle's stock or assets (collectively "Exempted Transfers") shall not be deemed an assignment for the purposes of this Agreement and therefore shall not require the consent of the City, provided that Crown Castle reasonably demonstrates to the City's lawfully empowered designee the following criteria (collectively the "Exempted Transfer Criteria"): (i) such transferee will have a financial strength after the proposed transfer at least equal to that of Crown Castle immediately prior to the transfer; (ii) any such transferee assumes all of Crown Castle's obligations hereunder; and (iii) the experience and technical qualifications of the proposed transferee, either alone or together with Crown Castle's management team, in the provision of telecommunications or similar services, evidences an ability to operate the Network. Crown Castle shall give at least thirty (30) days' prior written notice (the "Exempted Transfer Notice") to the City of any such proposed Exempted Transfer and shall set forth with specificity in such Exempted Transfer Notice the reasons why Crown Castle believes the Exempted Transfer Criteria have been satisfied. The City shall have a period of thirty (30) days (the "Exempted Transfer Evaluation Period") from the date that Crown Castle gives the City its Exempted Transfer Notice to object in writing to the adequacy of the evidence contained therein. Notwithstanding the foregoing, the Exempted Transfer Evaluation Period shall not be deemed to have commenced until the City has received from Crown Castle any and all additional information the City may reasonably require in connection with its evaluation of the Exempted Transfer Criteria as set forth in the Exempted Transfer Notice, so long as the City gives Crown Castle notice in writing of the additional information the City requires within fifteen (15) days after the City's receipt of the original Exempted Transfer Notice. If the City fails to act upon Crown Castle's Exempted Transfer Notice within the Exempted Transfer Evaluation Period (as the same may be extended in accordance with the foregoing provisions), such failure shall be deemed an affirmation by the City that Crown Castle has in fact established compliance with the Exempted Transfer Criteria to the City's satisfaction.

**10 MISCELLANEOUS PROVISIONS.** The provisions which follow shall apply generally to the obligations of the parties under this Agreement.

**10.1 *Nonexclusive Use.*** Crown Castle understands that this Agreement does not provide Crown Castle with exclusive use of any Municipal Facility and that the City shall have the right to permit other providers of communications services to install equipment or devices on Municipal Facilities. In addition, the City agrees to advise other providers of communications services of the presence or planned deployment of the Equipment in the Public Way and/or on Municipal Facilities.

**10.2 *Waiver of Breach.*** The waiver by either party of any breach or violation of any provision of this Agreement shall not be deemed to be a waiver or a continuing waiver of any subsequent breach or violation of the same or any other provision of this Agreement.

**10.3 *Severability of Provisions.*** If any one or more of the provisions of this Agreement shall be held by court of competent jurisdiction in a final judicial action to be void, voidable, or unenforceable, such provision(s) shall be deemed severable from the remaining provisions of this Agreement and shall not affect the legality, validity, or constitutionality of the remaining portions of this Agreement. Each party hereby declares that it would have entered into this Agreement and each provision hereof regardless of whether any one or more provisions may be declared illegal, invalid, or unconstitutional.

**10.4 *Contacting Crown Castle.*** Crown Castle shall be available by phone to the staff employees of any City department having jurisdiction over Crown Castle's activities twenty-four (24) hours a day, seven (7) days a week, regarding problems resulting from the attachment, installation, operation, maintenance, or removal of the Equipment. The City may contact by telephone the network operations center operator at (888) 632-0931 regarding any such problems.

**10.5 *Governing Law; Jurisdiction.*** This Agreement shall be governed and construed by and in accordance with the laws of the State of Georgia. If suit is brought by a party to this Agreement, the

parties agree that trial of such action shall be vested exclusively in the state courts of Dekalb County, Georgia, or in the United States District Court for the Northern District of Georgia.

**10.6 Attorneys' Fees.** Should any dispute arising out of this Agreement lead to litigation, the prevailing party shall be entitled to recover its costs of suit, including (without limitation) reasonable attorneys' fees.

**10.7 Consent Criteria.** In any case where the approval or consent of one party hereto is required, requested or otherwise to be given under this Agreement, such party shall not unreasonably delay, condition, or withhold its approval or consent.

**10.8 Representations and Warranties.** Each of the parties to this Agreement represents and warrants that it has the full right, power, legal capacity, and authority to enter into and perform the parties' respective obligations hereunder and that such obligations shall be binding upon such party without the requirement of the approval or consent of any other person or entity in connection herewith.

**10.9 Amendment of Agreement.** This Agreement may not be amended except pursuant to a written instrument signed by both parties.

**10.10 Entire Agreement.** This Agreement contains the entire understanding between the parties with respect to the subject matter herein. There are no representations, agreements, or understandings (whether oral or written) between or among the parties relating to the subject matter of this Agreement which are not fully expressed herein.

In witness whereof, and in order to bind themselves legally to the terms and conditions of this Agreement, the duly authorized representatives of the parties have executed this Agreement as of the Effective Date.

*[Signature Page Follows]*

**DOCUMENT DISCLOSURE:**

It is understood and agreed to by Crown Castle that this License and all information submitted by Crown Castle to the City in connection with Licensee's application for this License and all further information that may be submitted in connection with Licensee's rights and duties under this License shall be subject to public disclosure and copying upon request to City Information Systems by any person.

**ATTEST:**

**CROWN CASTLE NG EAST LLC**

Sign: \_\_\_\_\_

Sign: \_\_\_\_\_

Print: \_\_\_\_\_

Name: \_\_\_\_\_

Title: \_\_\_\_\_

**WITNESS:**

**CITY OF DUNWOODY**

\_\_\_\_\_

\_\_\_\_\_

Name: \_\_\_\_\_

Title: \_\_\_\_\_

WITNESS:

Sign: \_\_\_\_\_

\_\_\_\_\_

SIGNATURE OF WITNESS

Name: \_\_\_\_\_

Title: \_\_\_\_\_

\_\_\_\_\_

TYPE NAME OF WITNESS

**EXAMINED BY:**

**APPROVED TO FORM:**

\_\_\_\_\_

\_\_\_\_\_

Name: \_\_\_\_\_

Title: \_\_\_\_\_

TITLE

**Exhibits:**

Exhibit A - Equipment

*Exhibit A*



06/18/2015

# Exhibit A

Prepared for: **Name**

The Foundation for a Wireless World.

## Contents

<b>Equipment Configurations</b>	1
<b>Street-Light Pole</b>	2
<b>Traffic-Light Pole</b>	3
<b>Wooden Power Pole: Antenna in Communications Space</b>	4
<b>Wooden Power Pole: Pole-top Antenna</b>	5
<b>Wooden Power Pole: No Antenna</b>	6
<b>Wooden Power Pole: Pole-top Antenna, 2 Equipment Shrouds</b>	7
<b>Wooden Power Pole: Pole-top Antenna, Back-Back Shrouds</b>	8
<b>Pole-top Antenna Designs</b>	9
<b>Communications Space Antenna Designs</b>	10
<b>Equipment Shroud Designs</b>	11
<b>Equipment Shroud Designs</b>	12
<b>Battery Backup Unit</b>	13
<b>Ground Mounted Equipment</b>	14
<b>Battery Backup Unit on Ground</b>	15
<b>Custom Pole with Equipment</b>	16

## Equipment Configurations

The following equipment configurations and attachment scenarios are intended to be representative in nature. Actual installations may differ somewhat based upon various factors, including, but not limited to, the coverage and/or capacity objective, final equipment selection, field and pole conditions, existing pole attachments, utility construction standards, and future changes in technology.

Exhibit A

# Street-Light Pole

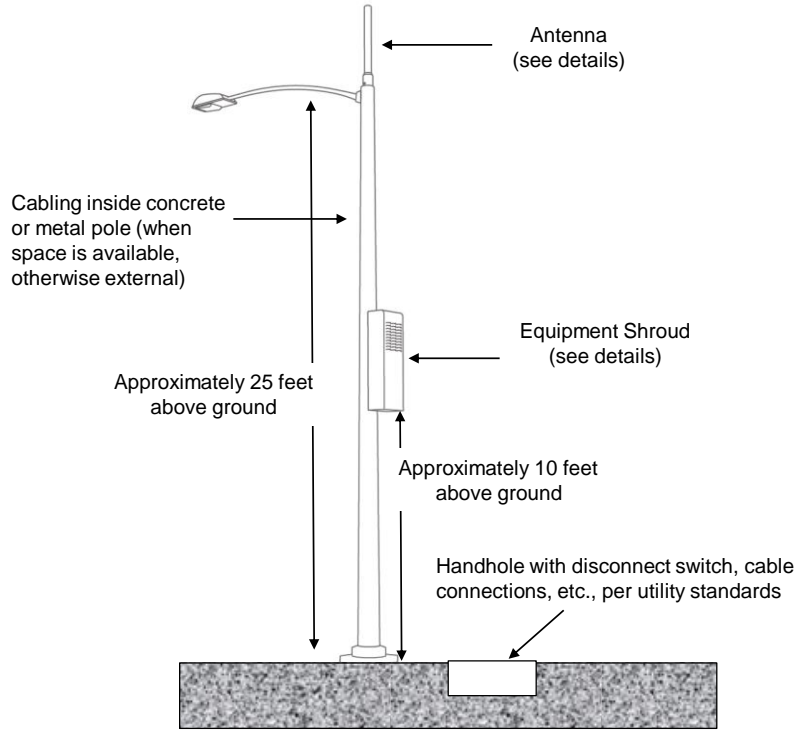

Scale approximate  
Construction will meet national and local utility safety codes

# Traffic-Light Pole

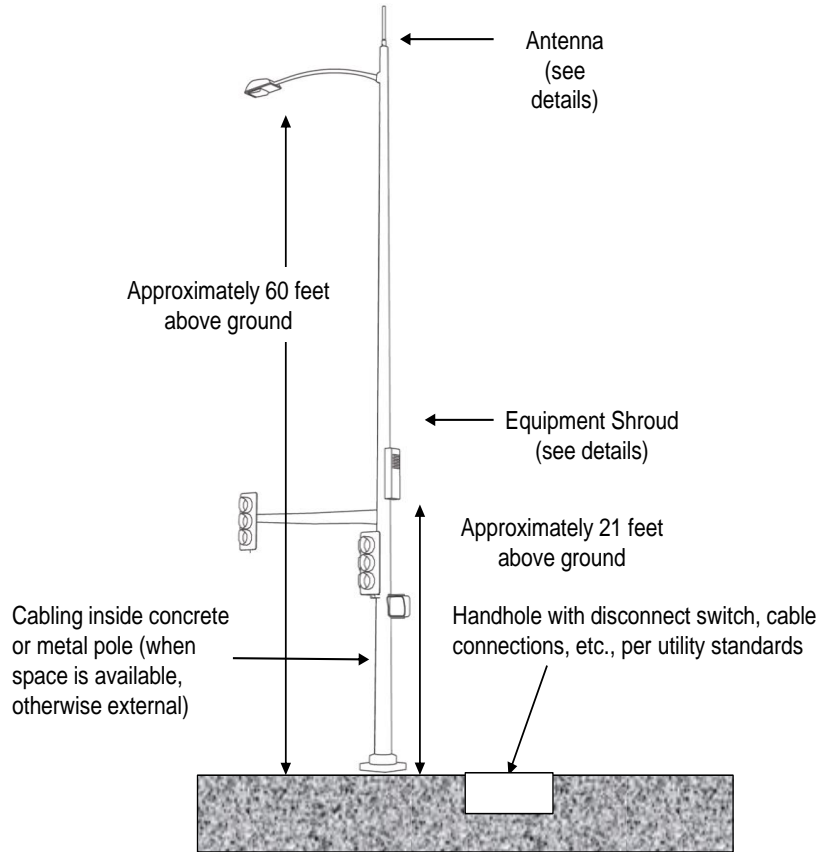

Scale approximate  
Construction will meet national and local utility safety codes



Exhibit A

# Wooden Power Pole: Antenna in Communications Space

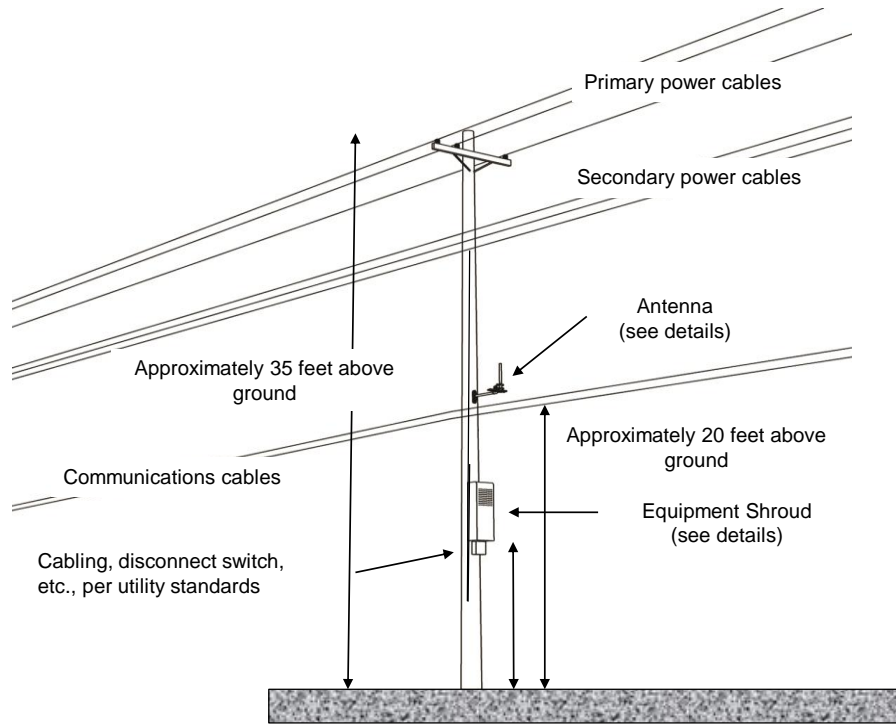

Scale approximate  
Construction will meet national and local utility safety codes

# Wooden Power Pole: Pole-top Antenna

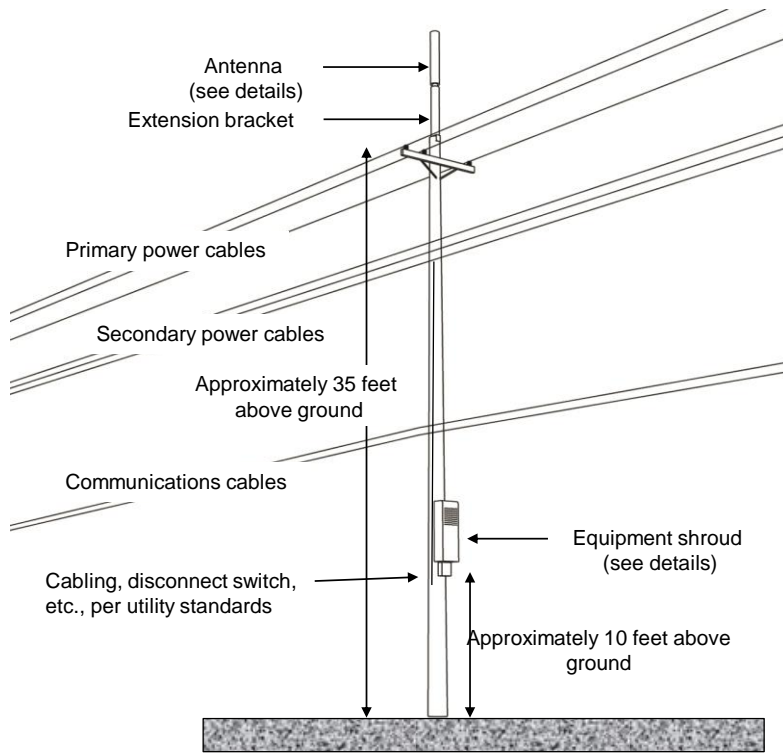

Scale approximate  
Construction will meet national and local utility safety codes

Exhibit A

# Wooden Power Pole: No Antenna

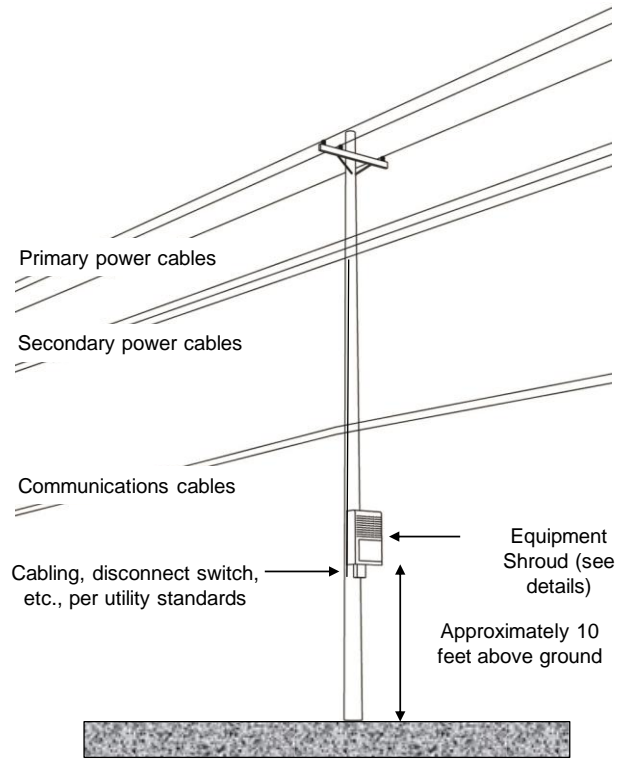

Scale approximate  
Construction will meet national and local utility safety codes

## Wooden Power Pole: Pole-top Antenna, 2 Equipment Shrouds

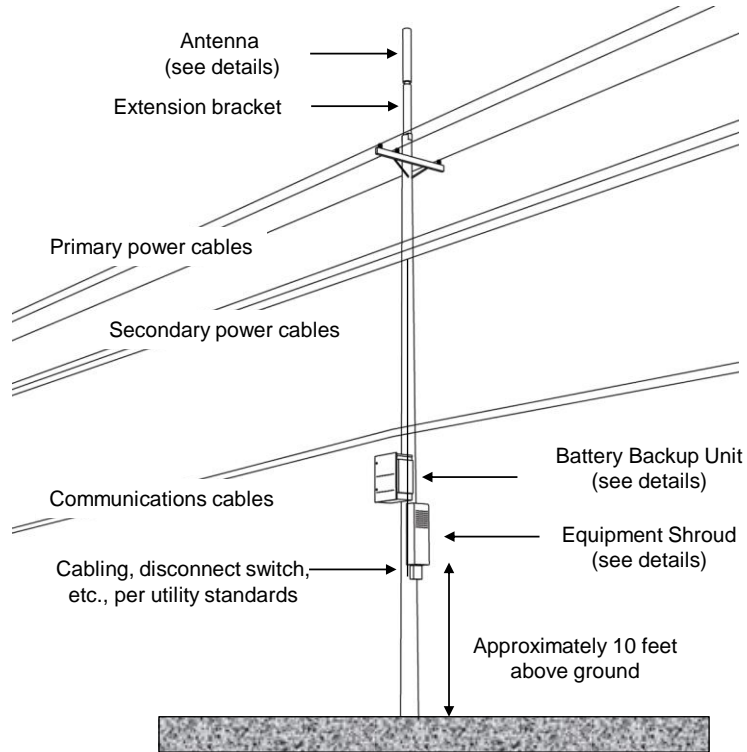

Scale approximate  
Construction will meet national and local utility safety codes

Exhibit A

# Wooden Power Pole: Pole-top Antenna, Back-Back Shrouds

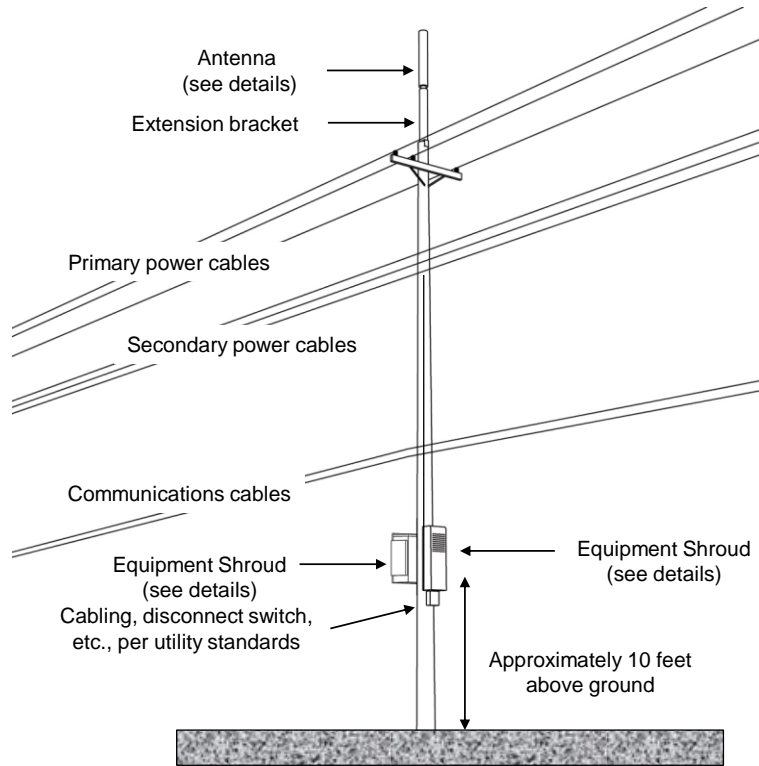

Scale approximate  
Construction will meet national and local utility safety codes

## Pole-top Antenna Designs

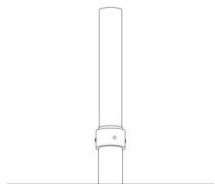

**Cylindrical-style antenna**  
24 to 50 inches high,  
2 to 10 inches in  
diameter



**Panel-style antenna(s)**  
each 24 to 58 inches high,  
8 to 12 inches wide,  
4 to 10 inches deep,  
Up to 3 panels per pole



**Cylindrical-style antenna**  
48 to 72 inches high,  
8 to 16 inches in diameter



**Drum-style antenna**  
24 to 26 inches high,  
16 to 20 inches in diameter



**Omni ("whip")-style antenna**  
48 to 72 inches high,  
1 to 3 inches in diameter



**Cylindrical-style antenna atop  
panel-style antenna(s):**  
cylinder 24 to 50 inches high,  
2 to 10 inches in diameter;  
each panel 24 to 58 inches  
high, 8 to 12 inches wide,  
4 to 10 inches deep,  
up to 3 panels per pole

Engineering and design determined on a site-by-site basis, some with extension bracket  
Scale approximate

Exhibit A

# Communications Space Antenna Designs



**Cylindrical-style antenna**  
24 to 36 inches high,  
2 to 14 inches in diameter



**Panel-style antenna(s)**  
each panel 24 to 36 inches  
high,  
8 to 12 inches wide,  
6 to 10 inches deep,  
Up to 3 panels per pole



**Drum-style antenna**  
24 to 26 inches high,  
16 to 20 inches in diameter

Scale approximate

## Equipment Shroud Designs

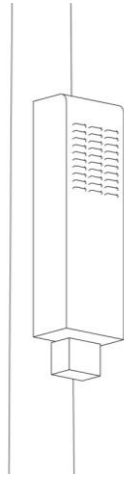

**Equipment Shroud**  
25 to 70 inches high,  
12 to 28 inches wide,  
10 to 25 inches deep

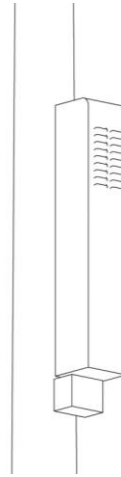

**Equipment Shroud**  
48 to 70 inches high,  
8 to 15 inches wide,  
8 to 12 inches deep

Scale approximate.

Mounting brackets, disconnect switch, electric meter (per utility standards), and associated attachments, such as channels, conduit, and grounding, to be constructed in accordance with national and local utility and safety codes.



Exhibit A

## Equipment Shroud Designs

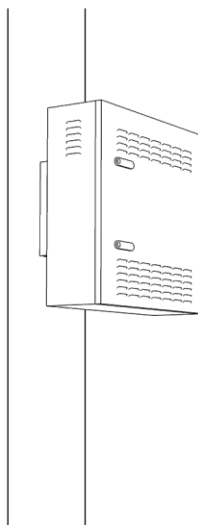

**Equipment Shroud**  
**48 to 52 inches high,**  
**48 to 52 inches wide,**  
**15 to 20 inches deep**

Scale approximate.

Mounting brackets, disconnect switch, electric meter (per utility standards), and associated attachments, such as channels, conduit, and grounding, to be constructed in accordance with national and local utility and safety codes.

## Battery Backup Unit

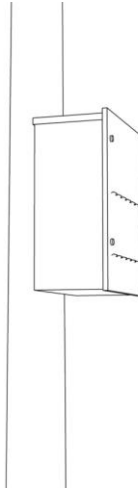

**Battery Backup Unit**  
**36 to 70 inches high,**  
**12 to 36 inches wide,**  
**8 to 24 inches deep**

Scale approximate.

Mounting brackets, disconnect switch, electric meter (per utility standards), and associated attachments, such as channels, conduit, and grounding, to be constructed in accordance with national and local utility and safety codes.

Exhibit A

## Ground Mounted Equipment

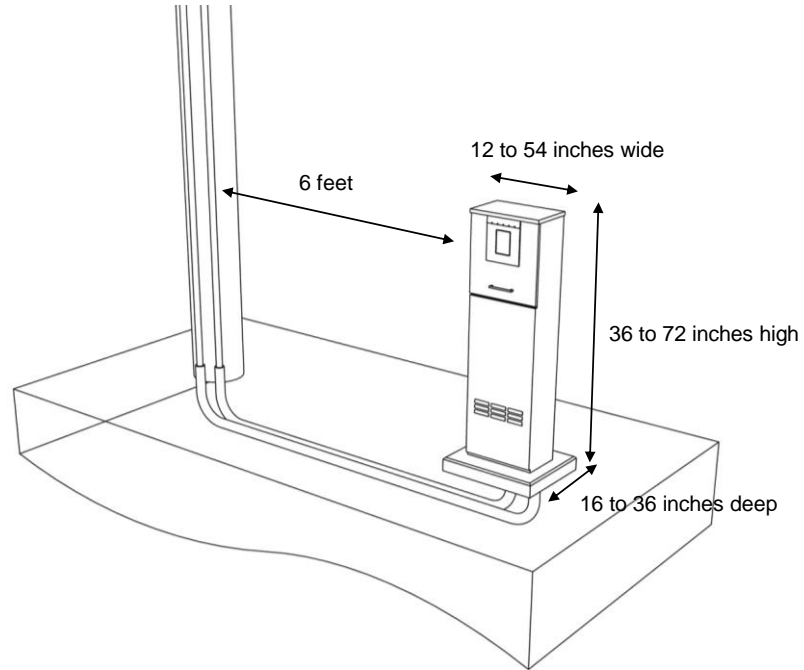

Scale approximate & dimensions are typical.

Mounting brackets, disconnect switch, electric meter (per utility standards), and associated attachments, such as channels, conduit, and grounding, to be constructed in accordance with national and local utility and safety codes.

## Battery Backup Unit on Ground

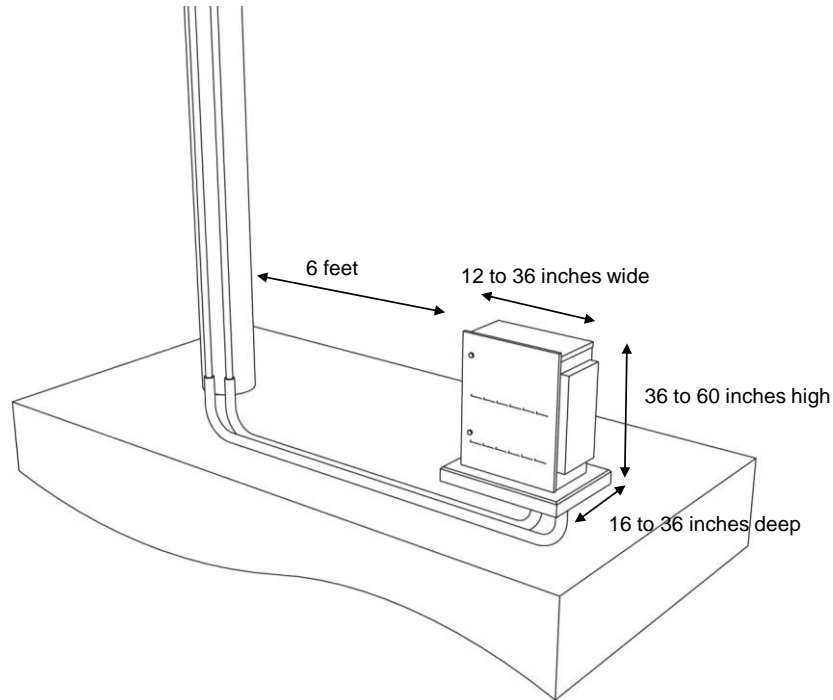

Scale approximate & dimensions are typical.  
Mounting brackets, disconnect switch, electric meter (per utility standards), and associated attachments, such as channels, conduit, and grounding, to be constructed in accordance with national and local utility and safety codes.

Exhibit A

# Custom Pole with Equipment

