



MEMORANDUM

To: Mayor and City Council
From: Billy Grogan, Chief of Police
Date: May 23, 2022

Subject: Approval of Flock Group, Inc. Additional Services Agreement to Lease Additional LPRs

ACTION

Authorize the mayor, city manager, or designee to sign the Flock Group, Inc. Additional Services Agreement authorizing the 27 additional LPR cameras, Raven audio detection devices, and Flock Safety advanced search.

BACKGROUND/SUMMARY

The City Council has previously made significant investments in LPR technology to help keep the citizens of Dunwoody safe. Over the last several years, the City installed 46 LPRs, primarily at entrance points into the City, in the perimeter area, and the parks.

The Dunwoody Police Department has used the LPRs to effectively arrest Wanted Persons, including a suspect wanted for Murder, and recover Stolen Autos and Stolen Tags. In addition, investigators used historical LPR data to identify suspects in numerous investigations, which have led to multiple arrests.

A careful review of our LPR program revealed a gap in LPR coverage in the interior parts of the City. Adding 27 LPRs at critical points on many of our main internal thoroughfares will help improve the effectiveness of our LPR program.

Additionally, we have had a significant increase in gun violence recently, especially on the east side of Dunwoody at the apartment complexes on Peachtree Industrial Blvd and Winters Chapel Road. This proposal includes adding Raven audio detection devices in a .25-mile area to help improve our detection and response to gunfire.



4800 Ashford Dunwoody Road
Dunwoody, Georgia 30338
dunwoodyga.gov | 678.382.6700

Lastly, this agreement also gives investigators access to Advanced Search capability, which will be used to improve the identification of suspect vehicles used in the commission of various crimes.

RECOMMENDATION

Staff recommends the City Council approve the Additional Service Agreement with Flock Group, Inc. and authorize the mayor, city manager, or designee to sign it. The Additional Services Agreement has been reviewed by legal and is subject to final legal review.

FLOCK GROUP INC.
ADDITIONAL SERVICES AGREEMENT

This Agreement combined with the existing agreement referenced in **Exhibit A** describe the relationship between Flock Group Inc. (“**Flock**”) and the customer identified below (“**Customer**”) (each of Flock and Customer, a “**Party**”). This order form (“**Order Form**”) hereby incorporates and includes the terms of the previously executed agreement (the “**Terms**”) which describe and set forth the general legal terms governing the relationship (collectively, the "**Agreement**"). The Terms contain, among other things, warranty disclaimers, liability limitations and use limitations.

This additional services Agreement will be effective when this Order Form is executed by both Parties (the “**Effective Date**”).

Agency: GA - City of Dunwoody - Government Legal Entity Name:	Contact Name: Billy Grogan
Address: 4800 Ashford Dunwoody Rd Atlanta, Georgia 30338	Phone: (678) 382-6902 E-Mail: billy.grogan@dunwoodyga.gov
Expected Payment Method:	Billing Contact: (if different than above)

Initial Term: 24 months Renewal Term: 24 months	Billing Term: Annual payment due Net 30 per terms and conditions
--	---

Sales tax will be added to all fees as applicable. **If your organization is tax exempt, please check this box: and email your Sales Tax Exemption Certificate to billing@flocksafety.com.**

Name	Price/Usage Fee	QTY	Subtotal
Raven Audio Detection Device 1/4 Mile	\$8,500.00	1.00	\$8,500.00
Flock Safety Advanced Search >50 Falcons	\$5,000.00	1.00	\$5,000.00
Professional Services - Falcon, Standard Implementation	\$350.00	27.00	\$9,450.00
Falcon Camera	\$2,500.00	27.00	\$67,500.00

(Includes one-time fees)

Year 1 Total: \$90,450.00

Recurring Total: \$81,000.00

By executing this Order Form, Agency represents and warrants that it has read and agrees to all of the terms and conditions contained in the Terms attached. The Parties have executed this Agreement as of the dates set forth below.

FLOCK GROUP, INC.

Agency: GA - City of Dunwoody - Government

By: _____

By: _____

Name: _____

Name: **Billy Grogan**

Title: _____

Title: _____

Date: _____

Date: _____

EXHIBIT A

This agreement is governed by the terms as set out in this attached agreement that has been previously executed by both parties.

flock safety

Let's defeat crime together

Customer Implementation Guide: Law Enforcement

Contents

- Implementation Timeline 2**
- Implementation Team 3**
- Implementation Service brief: Standard VS Advanced 6**
 - Standard Implementation 6
 - Advanced Implementation 8
- Things to Consider when Picking Locations 10**
- Customer Responsibilities: AC-Powered Cams 11**
- Electrician Handout 12**
 - Electrician Installation Steps 12
 - FAQs about AC-Powered Flock Cameras 13
- Installation Service Brief Summary 15**
- Permitting: Pre-Install Questionnaire 16**
 - 1. Timeline 16
 - 2. Right of Way 16
 - 3. AC Power vs. Solar 16
 - 4. Traffic Control & Installation Methods 16
 - 5. Paperwork & Required Forms 17
 - 6. Contacts 17
- Professional Services Fee Schedule 17**
- Billing 18**
- Help Center 19**
- Customer Support 19**



Implementation Timeline

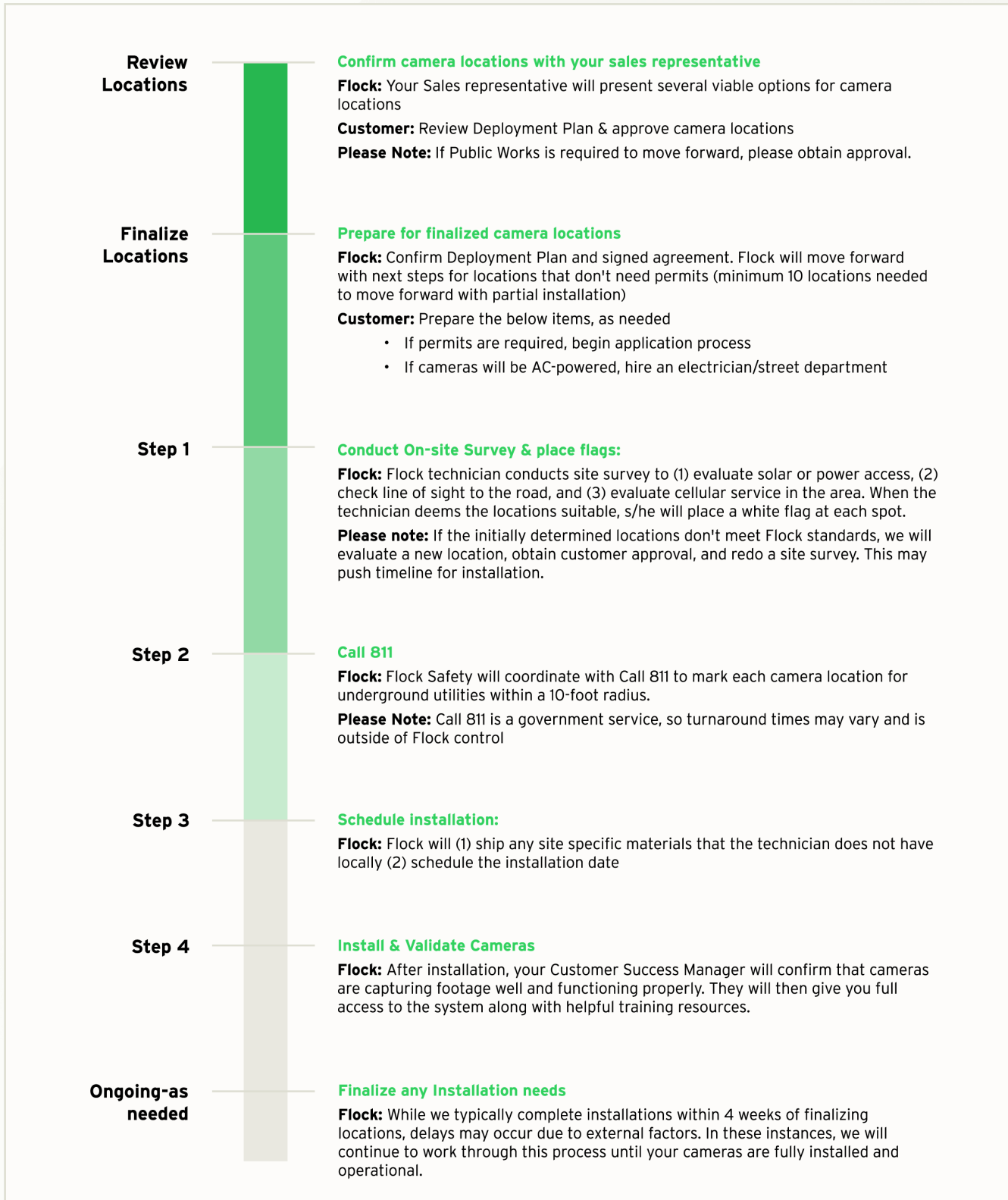

This timeline provides general guidance and understanding of your installation process. While we typically complete installations 6-8 weeks after locations have been finalized, delays can occur as noted in the timeline below:



Implementation Team

Implementation Team	How they will support you
<p>Project Manager</p> 	<p>Your Project Manager is your primary contact during camera installation.</p> <ul style="list-style-type: none"> Your project manager will guide you through the entire installation process, keeping you apprised of all implementation updates as well as answering any questions you have during this time. They will ensure that all the cameras are on the ground and operating for at least 48 hours before transitioning you to your Customer Success Manager.
<p>Field Operations Team</p> 	<ul style="list-style-type: none"> The Field Operations team is responsible for the physical installation and maintenance of cameras and associated equipment provided by Flock. This includes a large team of technicians, schedulers, and many others involved in ensuring the delivery of the product. They take the technical plan you finalized with Product Implementation and work closely with other teams at Flock to make sure that the cameras are installed quickly and safely and in a way that maximizes the opportunity to solve crime at a specific location. *Note*: For all Installation questions or concerns, please always direct them to your Customer Success Manager and not the technician.
<p>Product Implementation Specialist</p> 	<p>Your Product Implementation Specialist is your technical product expert.</p> <p>They will help translate your goal for using Flock Safety cameras into a technical plan that can be executed and enable you to solve crime. Your specialist will work your Sales Rep to:</p> <ul style="list-style-type: none"> Review the cameras in your deployment Ensure that the deployment plan is set up for success from a technological standpoint in addition to meeting your goals for the product If any of your locations require permits, a member of the Product Implementation team will assist you in packaging your application(s).



Relationship Team	How they will support you
<p data-bbox="235 317 370 420">Customer Success Manager</p> 	<p data-bbox="488 317 1393 380">Your Customer Success Manager is your strategic partner for your lifetime as a Flock customer.</p> <p data-bbox="488 407 1369 470">While the cameras are getting installed, your CSM will help get your account set up and get all key users trained on the system.</p> <p data-bbox="488 495 1422 558">Post-Camera-Installation, your CSM will be your go-to for most account-related needs: You should reach out to them to:</p> <ul data-bbox="516 583 1373 867" style="list-style-type: none"> • Set up Account Training • Understand benefits of features • Learning best practices for getting relevant data • Identifying opportunities to expand the security network in your area • Provide feedback on your partnership with Flock
<p data-bbox="215 930 389 993">Flock Safety Support</p> 	<p data-bbox="488 930 1414 1024">The Flock Safety Support team is committed to answering all your day-to-day questions as quickly as possible. To get in touch with support, simply email support@flocksafety.com. Support can help you:</p> <ul data-bbox="516 1050 1159 1356" style="list-style-type: none"> • Request camera maintenance • Troubleshoot online platform • Contract / Billing questions • Update account information • Camera Sharing questions • Quick “How to” questions in your Flock Account

Please Note: On some occasions, third parties outside of Flock Safety may be (or need to be) involved in your implementation.

Outside Party	When they may be involved
Electrician/ Street Department	If the Flock cameras need to be AC powered, you (customer) are responsible for providing an electrician to ensure power connectivity
Public Works (LE)	To weigh in on the use of public Rights of Way or property
Department of Transportation (DOT), City, or County agencies	If installation in your area requires permitting

Implementation Service brief: Standard VS Advanced

Standard Implementation

Cost = \$350 / camera (one time cost)

Included in scope:

Once Designated Locations are confirmed, as part of the **Standard Implementation Service** Flock will perform the following:

- An in-person site survey to confirm the installation feasibility of a location (location assessment, solar assessment, visibility review, etc.)
- Confirm that a location is safe for work by following State utility locating procedures. Work with local utilities to prevent service interruptions during the installation
 - Engage 811 'Call-before-you-Dig' system to receive legal dig date
 - Apply approved markings Coordinate with 811 regarding any necessary high-risk dig clearances or required vendor meets
- Each installation may include the following:
 - Installation of camera and solar panel with **standard, 12' above grade Flock breakaway pole**
 - Installation of camera and solar panel on a suitable existing pole, no higher than 8-12' (approval at Flock Safety's discretion)
 - Installation of camera and AC adapter that a qualified electrician can connect to AC power on a suitable existing pole, no higher than 8-12' (approval at Flock Safety's discretion)
 - *Flock will provide and mount an AC adapter that a qualified electrician can connect to AC power following our electrical wiring requirements ([link](#)). Flock is unable to make any AC connections or boreholes in any material other than dirt, grass, loose gravel (or other non-diggable material). Electrical work requiring a licensed electrician and associated costs, not included in the scope.*
 - Access requiring up to a 14' A-frame ladder
 - Standard MUTCD traffic control procedures performed by a Flock technician
- Obtain a business license to operate in the City and State of camera location

Not included in scope:

Flock does **not** include the following as part of the Standard Implementation Service but can provide a quote for sourcing at an additional cost:

- Cannot NCHRP 350 or MASH approved pole (as may be required for locations in DOT right of way)
- A Bucket Truck for accessing horizontal/cross-beams
- Site-specific engineered traffic plans
- Third-party provided traffic control
- State or City-specific specialty contractor licenses
- Custom engineered drawings
- Electrical work requires a licensed electrician. Flock will provide and mount an AC adapter that a qualified electrician can connect to AC power but cannot make any AC connections or boreholes in any material other than dirt, grass, loose gravel (or other non-diggable material).
- Private utility search for privately owned items not included in standard 811 procedures (communication, networking, sprinklers, etc.)
- Upgrades to power sources to ready them for Flock power (additional fuses, switches, breakers, etc.)
- Any fees or costs associated with filing for required City, County, or State permits

Advanced Implementation

Cost = \$750 / camera (one time cost)

Included in scope: Once Designated Locations are confirmed, as part of the **Advanced Implementation Service**, Flock will perform the following:

- An in-person site survey to confirm the installation feasibility of a location (location assessment, solar assessment, visibility review, etc.)
- Confirm that a location is safe for work by following State utility locating procedures. Work with local utilities to prevent service interruptions during the installation
 - Engage 811 'Call-before-you-Dig' system to receive legal dig date
 - Apply approved markings Coordinate with 811 regarding any necessary high-risk dig clearances or required vendor meets
- Each installation may include the following:
 - Installation of camera and solar panel with **standard, 12' above grade Flock breakaway pole**
 - Installation of camera and solar panel on a suitable existing pole, no higher than 8-12' (approval at Flock Safety's discretion) or **NCHRP 350 or MASH approved pole**, if necessary.
 - **Pole Options - Northern and Coastal**
 - **Pole Options - Non-Winterized, Non-Coastal**
 - **Pole Options - Georgia**
 - **Pole Options - Texas**
 - Installation of camera and AC adapter that a qualified electrician can connect to AC power on a suitable existing pole, no higher than 8-12' (approval at Flock Safety's discretion)
 - Flock will provide and mount an AC adapter that a qualified electrician can connect to AC power following our electrical wiring requirements ([link](#)). Flock cannot make any AC connections or boreholes in any material other than dirt, grass, loose gravel (or other non-diggable material). Electrical work requiring a licensed electrician and associated costs, not included in the scope.
 - Access requiring up to a 14' A-frame ladder
 - Standard MUTCD traffic control procedures performed by a Flock technician
- Obtain a business license to operate in the City and State of camera location

Not included in scope:

By default, Flock does **not** include the following as part of the Advanced Implementation Service but can optionally provide a quote for sourcing (additional cost):

- A Bucket Truck for accessing horizontal/cross-beams
- Site-specific engineered traffic plans
- Third-party provided traffic control
- State or City-specific specialty contractor licenses
- Custom engineered drawings
- Electrical work requires a licensed electrician. Flock will provide and mount an AC adapter that a qualified electrician can connect to AC power but cannot make any AC connections or boreholes in any material other than dirt, grass, loose gravel (or other non-diggable material).
- Private utility search for privately owned items not included in standard 811 procedures (communication, networking, sprinklers, etc.)
- Upgrades to power sources to ready them for Flock power (additional fuses, switches, breakers, etc.)

Any fees or costs associated with filing for required City, County, or State permits



Things to Consider when Picking Locations

Falcon Cameras

- Use Cases
 - Flock LPRs are designed to capture images of rear license plates aimed in the direction of traffic.
 - Flock LPRs are not designed to capture pedestrians, sidewalks, dumpsters, gates, other areas of non-vehicle traffic, intersections.
- Placement
 - They capture vehicles driving away from an intersection.
 - They cannot point into the middle of an intersection.
 - They should be placed after the intersection to prevent stop and go motion activation or “stop and go” traffic.
- Mounting
 - They can be mounted on existing utility, light, traffic signal poles, or 12 foot Flock poles. ****NOTE**** *Permitting (or permission from pole owner) may be required to use existing infrastructure or install in specific areas, depending on local regulations & policies.*
 - They should be mounted one per pole*. If using AC power, they can be mounted 2 per pole.
 - *Cameras need sufficient power. Since a solar panel is required per camera, it can prevent adequate solar power if two cameras and two solar panels are on a single pole (blocking visibility). Therefore if relying on solar power, only one camera can be installed per pole.
 - They can be powered with solar panels or direct wire-in AC Power (no outlets). ****NOTE**** Flock does not provide Electrical services. Once installed, the agency or community must work with an electrician to wire the cameras. Electrician services should be completed within two days of installation to prevent the camera from dying.
 - They will require adequate cellular service using AT&T or T-Mobile to be able to process & send images.

Solar Panels

- Solar panels need unobstructed southern-facing views.

Pole

- If a location requires a “DOT Pole” (i.e., not Flock standard pole), the implementation cost will be \$750/camera.

Customer Responsibilities: AC-Powered Cams

If the Flock cameras need to be AC-powered, the customer is responsible for acquiring an electrician and ensuring they connect the camera to power. **See steps 2 and 6 below.**



Don't Let Access to Solar Limit Your Power Needs

The Flock Safety license plate reading camera system can leverage AC power to help your community solve crime no matter the location.



Easy to Use Install Power Kit

Work with Local Electricians

Efficient Quote & Installation Process

How to Get Started with a Powered Install

- 1. Create a Deployment Plan**
Work with Flock to select the best location(s) for your cameras and power sources.
- 2. Acquire an Electrical Quote**
Contact an electrician to receive a quote to run 120volt AC power to the camera.
- 3. Sign Flock Safety Agreement**
Sign the Flock Safety purchase order to begin the installation of the cameras.
- 4. Conduct Site Survey**
Flock will mark camera locations, locate underground utilities and mark if present.
- 5. Install Camera**
Flock will install the camera and AC power kit at the specified camera location.
- 6. Connect Camera to Power**
Notify the electrician that the camera is ready for the power connection installation.

Visit [flocksafety.com/power-install](https://www.flocksafety.com/power-install) for the complete plan, FAQs & to get started!

Electrician Handout

Electrician Installation Steps

1. Run AC cable and conduit to the box according to NEC Article 300 and any applicable local codes. The gland accepts 1/2" conduit.
2. Open the box using hinges.
3. Connect AC Mains per wiring diagram below:
 - Connect AC Neutral wire to the Surge Protector white Neutral wire using the open position on the lever nut.
 - Connect AC Line wire to the Surge Protector black Line wire using the open position on the lever nut.
 - Connect AC Ground wire to the Surge Protector green ground wire using the open position on the lever nut.
4. Verify that both the RED LED is lit on the front of the box
5. Close box and zip tie the box shut with the provided zip tie
6. While still on-site, call Flock, who will remotely verify that power is working correctly:

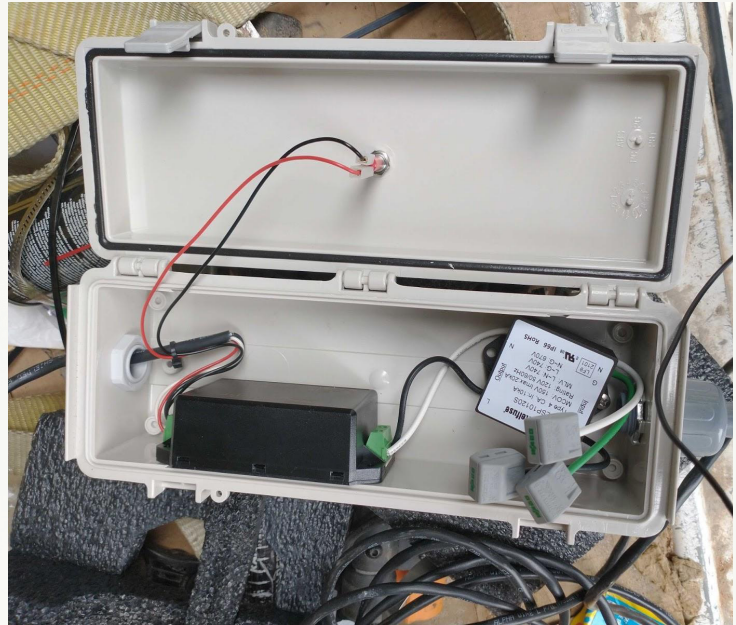

Southeast Region - (678) 562-8766

West-Region - (804) 607-9213

Central & NE Region - (470) 868-4027

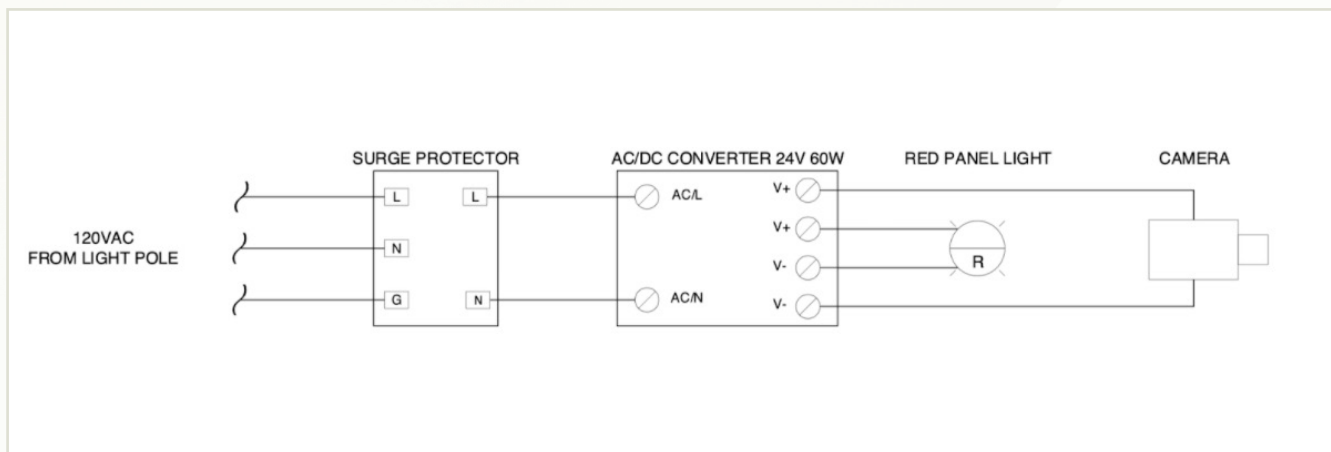

FAQs about AC-Powered Flock Cameras

- **What voltage is supported?** The AC kit is designed to work with 120VAC infrastructure by default. A 240VAC version is available on request.
- **How much power does this consume?** Peak current draw is 1.5 A at 120VAC. The average power draw is roughly 30W in high traffic conditions but maybe lower when fewer vehicles are present.
- **Who is responsible for contracting the electrician?** The customer is responsible for contracting an electrician. We can help answer questions, but the customer is responsible for identifying and contracting an electrician.
- **Who is responsible for maintenance?** Flock will handle all maintenance related to Flock's camera and power equipment. However, any problems with the electrical supply are the customer's responsibility. The AC junction box has two lights to indicate the presence of power and make it easy for quick diagnosis if there is a problem related to the AC power source.
 - If the camera indicates to Flock that there is a power supply problem, Flock will notify the customer and request that the customer verifies the lights on the AC junction box. If the AC Source light is illuminated, Flock will send a technician to investigate. If the AC source light is not illuminated, the customer should check any GFCI's or breakers in the supply circuit or call the electrician who installed the power supply.
- **How much does it cost?** Work required to bring AC power to each location will be different, so exact pricing is unavailable. Primary cost drivers include arrow boards and the distance from the camera location to the AC power source.
- **What information do I need to provide my electrician?** The Flock deployment plan and these work instructions should be sufficient to secure a quote. It will be helpful if you know the location of the existing power infrastructure before creating the deployment plan.
- **Can you plug it into my existing power outlet?** The Flock AC power adapter does not use a standard outlet plug but must be directly wired into the power mains. While using outlet plugs may be convenient, they can easily be unplugged, presenting a tampering risk to this critical safety infrastructure. The electrician can route power directly to the camera with a direct wire-in connection if an outlet is close to the camera.
- **How long does this process typically take?** The installation process typically takes 6-8 weeks. To accelerate the process, be sure to have the electrician perform his work shortly after the Flock technician finishes installing the camera.
- **What kind of electrician should I look for?** Any licensed electrician should perform this work, though we have found that those who advertise working with landscape lighting are most suited for this work.
- **What happens if the electrician damages the equipment?** The customer is responsible for contracting the electrician. Any liability associated with this work would be assumed by the customer. If any future work is required at this site due to the electrical infrastructure or the work performed by the electrician would be the responsibility of the customer.

- **When should the electrician perform his work?** Once Flock installs the camera, you will receive an email alert letting you know that this has been completed. After this, you will need to schedule the electrician to route power to the pole.
- **What if my electrician has questions about Flock's AC Kit?** You should share the **AC-Power Kit Details** packet with the electrician if they have questions.
- **What if the AC power is on a timer?** Sometimes the AC power will be on a timer (like used for exterior lighting). Flock requires that the AC power provided to the camera be constant. The source that the electrician uses must not be on a timing circuit.



Installation Service Brief Summary

Below outlines the statement of work for the Flock Camera Installation:

What is covered by Flock	What is NOT covered by Flock	Special note
Flock Cameras & Online Platform	Traffic Control and any associated costs	
Mounting Poles	*DOT Approved Pole cost Electrician & ongoing electrical costs	
AC Power Kit (as needed)	Engineering Drawings	
Solar Panels (as needed)	Relocation Fees	<i>Excluding changes during initial installation</i>
Site Surveys and Call 811 Scheduling	Contractor licensing fees	
Installation Labor Costs	Permit application processing fees	
Customer Support / Training	Specialist mounting equipment	<i>Including, but not limited to, **MASH poles or adapters</i>
Cellular Data Coverage	Bucket trucks	
Maintenance Fees (review Fees Sheet for more details)	Loss, theft, damage to Flock equipment	
Data storage for 30 days	Camera downtime due to power outage	<i>Only applicable for AC-powered cameras</i>

*If a location requires a "DOT pole" (i.e., not our standard), the implementation cost will be \$750/camera; This cost is applicable for installations in GA, IL, SC, TN, and CA.

**MASH poles: Manual for Assessing Safety Hardware (MASH) presents uniform guidelines for crash testing permanent and temporary highway safety features and recommends evaluation criteria to assess test results

Permitting: Pre-Install Questionnaire

1. Timeline

- In Flock Safety's experience, in-depth permitting requirements can **add 2+ months to the installation timeline**. Law enforcement agencies and city governments can work with their local Public Works or Department of Transportation offices directly to help expedite the process. When Flock Safety customers manage the permitting processes, results tend to come more quickly.
- Can your agency own the permitting process with Flock Safety's assistance?

2. Right of Way

- Will any Flock Safety cameras be installed on the city, state, or power company-owned poles or in the city, county, or state Right of Way (RoW)?
 - What is the RoW buffer?
 - Will additional permits or written permission be required from third-party entities (such as DOT, power companies, public works, etc.)?
- Will any cameras be installed on city-owned traffic signal poles (vertical mast)?
 - If yes, please provide heights/photos to determine if a bucket truck is needed for the installation.
 - Note: A bucket truck is required if the height exceeds 15 feet tall.

3. AC Power vs. Solar

- If AC powered, is there a 120V power source available, and is there access to an electrician who can connect the existing wire to the Flock Safety powered installation kit? (**Link**)
- If solar-powered, consider the size of the solar panel and potential to impact the visibility of DOT signs/signals:
 - Single Panel: 21.25" x 14" x 2" (Length x Width x Depth)
 - Double Panel: 21.25" x 28" x 2" (LxWxD)

4. Traffic Control & Installation Methods

- **If a bucket truck is required**, this typically necessitates an entire lane to be blocked in the direction of travel. **Can you provide a patrol car escort, or will full traffic control be required?**
 - Note: If traffic control is required, you may incur additional costs due to city/state requirements; Fees will be determined by quotes received.
- **If full traffic control is required (cones, arrow boards, etc.):**
 - Will standard plans suffice, or are custom plans needed? Custom plans can double the cost, while standard plans can be pulled from the Manual of Uniform Traffic Control Devices (**MUTCD**).
 - Will a non-sealed copy of the traffic plan suffice? Or does the traffic plan need to be sealed and/or submitted by a professional engineer?
 - Are there state-specific special versions/variances that must be followed?

- **If a bucket truck is *not* required**, the shoulder or sidewalk should suffice and enable Flock Safety to proceed without traffic control systems in place.
 - Note: In some states (i.e., arrow boards), sidewalks may require signage. If signage is mandatory, Will your Public Works department be able to assist?

5. Paperwork & Required Forms

- Flock Safety will need copies of paperwork to complete before proceeding (ex., business license applications, encroachment permit applications). We can save critical time by gathering these documents upfront. We appreciate your assistance in procuring these.

6. Contacts

- If Flock Safety needs to interface directly with the departments, please share the contact information of the following departments:
 - Permitting
 - Public Works
 - Traffic Department

Professional Services Fee Schedule

- Camera relocation, existing pole non-AC powered = \$350
- Camera relocation, Flock pole and/or AC powered = \$750
- Camera replacement as a result of vandalism, theft, or damage = \$500
- Pole replacement as a result of vandalism, theft, or damage = \$500
- Trip charge = \$350
- Examples:
 - Angle adjustment (elective)
 - Install additional Flock signage

Billing

5.1b Falcon Fees. For Falcon products during the Initial Term, Agency will pay Flock fifty percent (50%) of the first Usage Fee, the Implementation Fee, and any fee for Hardware (as described on the Order Form, together with the "Initial Fees") as set forth on the Order Form on or before the 30th day following receipt of initial invoice after Effective Date. Upon commencement of installation, Flock will issue an invoice for twenty-five percent (25%) of the Initial Fees. The Agency shall pay on or before the 30th day following receipt of the invoice.

Upon completion of installation, Flock will issue an invoice for the remaining balance, and Agency shall pay on or before the 30th day following receipt of the final invoice. Flock is not obligated to commence the Installation Services unless and until the first payment has been made and shall have no liability resulting from any delay related thereto. For a Renewal Term, as defined below, Agency shall pay the entire invoice on or before the anniversary of the Effective Date.

6.1b Falcon Term. Subject to earlier termination as provided below, the initial term of this Agreement shall be for the period of time set forth on the Order Form (the "**Initial Term**"). The Term shall commence upon first installation and validation of a Unit. Following the Initial Term, unless otherwise indicated on the Order Form, this Agreement will automatically renew for successive renewal terms for the length set forth on the Order Form (each, a "**Renewal Term**," and together with the Initial Term, the "**Service Term**") unless either party gives the other party notice of non-renewal at least thirty (30) days before the end of the then-current term.



Help Center

Our Help Center is filled with many resources to help you navigate through the online platform. Below you will find some common questions and their relevant help article:

How do I search camera footage?

How do I add a user?

How do I add a vehicle to my own Hot List?

How do I enable browser notifications for Hot List alerts?

How do I get text alerts for Hot List?

How do I request camera access from other nearby agencies?

How do I use the National Lookup to search for a plate? (*National Lookup - network of law enforcement agencies that have opted to allow their network of Flock cameras to be used for searches*)

How do I reset my / another user's password?

Customer Support

You can reach our customer support team anytime by emailing **support@flocksafety.com**. They can help answer any "How-To" questions you may have.





flock safety

Increase response time and case clearance with integrated audio and ALPR evidence capture

Flock Safety Raven™ Audio Detection Device

Raven integrates directly with the Flock Safety Falcon™ ALPR camera. The device recognizes audio signatures typical of crimes in progress like gunshots, screeching tires, breaking glass, and consolidates that evidence with Falcon ALPR data into one streamlined system.

**Detect gunshots and other crimes in progress
anywhere you deploy ALPR**

-  Gunfire
-  Breaking glass
-  Screeching tires



- Homicide
- Burglary / Vandalism
- Street racing

**Uncover real-time,
actionable leads**

- Raven detects gunfire and alerts the nearest camera.
- Falcon captures the Vehicle Fingerprint for the suspect vehicle.
- Dispatch verifies the call for service in FlockOS, deploys first responders, and sets up a Hot List alert.
- Patrol Officers receive a hit from another Falcon camera and pursue the suspect vehicle to make an arrest.

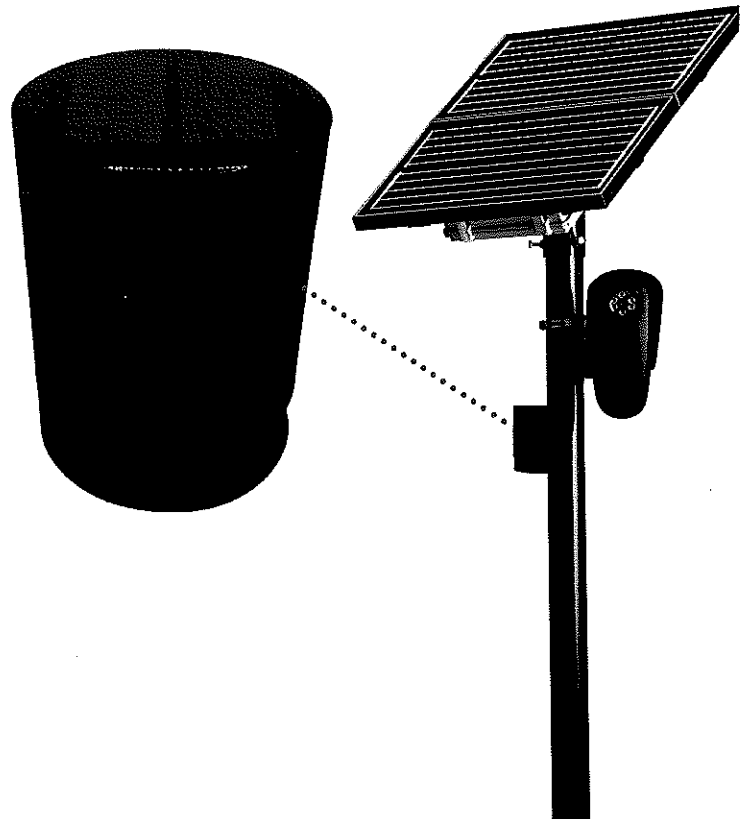

flock safety

Advanced Search + Automatic Vehicle Location (AVL)

Overview

Upgrade your FlockOS experience to unlock more investigative leads and build stronger cases with less information. The Advanced Search software package includes Convoy Analysis, Multi-Geo Search, Visual Search, and Cradlepoint Integration for Automatic Vehicle Location (AVL).

Advanced Search

Not every investigation starts with a vehicle description or plate number. The Advanced Search package transforms alternative intelligence, like neighborhood security footage, a primary suspect vehicle description, or multiple crime locations, into the critical piece of evidence for solving over 70% of crimes -- a suspect vehicle.

Visual Search

Upload any digital image (i.e. Ring doorbell footage, CCTV stills, or mobile phone pictures) to conduct a vehicle search.

Multi-Geo Search

Connect crimes across different locations to a common suspect vehicle to expedite case clearance and prevent repeat offenses.

Convoy Analysis

Identify vehicles frequently traveling together to identify accomplices in organized crimes (i.e. MV theft & drug trafficking).

Cradlepoint AVL

The Flock OS + Cradlepoint integration brings live patrol locations into the Flock OS map view, giving dispatchers more context to deploy resources effectively and decrease incident response times from a single platform when a Hot List hit occurs.

Number of ALPR Cameras	Annual Subscription Price
< 25	\$2500
25-49	\$3500
50	\$5000

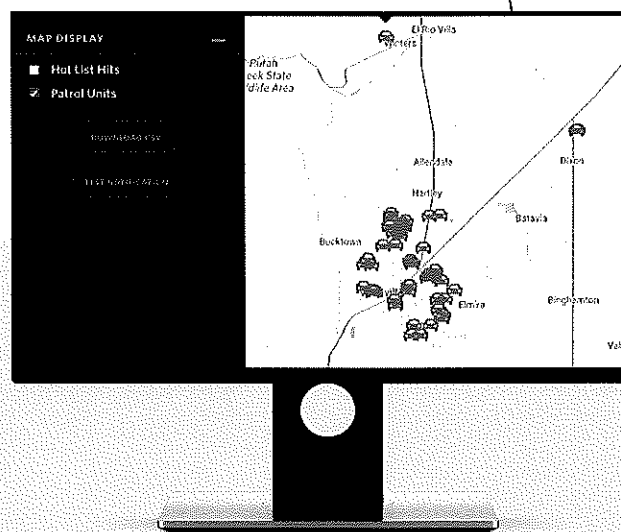

View ALPR Cameras, Hot List alerts, and live patrol vehicle locations from a single map.